

FeBOX

Phone Booth or Meeting Pod

Contents

01-02

Company Profile

03-24

Production Introduction and More Details

Fe⁺S05-12

Fe⁺M13-16

Fe⁺C17-18

Fe⁺R19-20

Fe⁺G21-22

Fe⁺W23-24

25-26

Application

27

Test Report

28

Production Process



Company Profile



We design and manufacture solutions which can help you create inspiring space division products. We use a numerous and powerful product portfolio as the basis for the design of a healthy office space, which not only ensures the safety of the office environment, but also allows your company to remain flexible and maximize space utilization.

For a long time, DAITACHI has been providing products for offices, shopping malls, hotels and other public spaces. We have extensive project experience. We have prepared a comprehensive cooperation process for clients and architects to realize their various innovative ideas. Our company has been committed to: designing, developing, crafting, manufacturing, selling and installing products for construction, office and various community areas. We always adhere to our philosophy: excellent design, quality, and customer satisfaction.

Every project, all of them play an important role to us, and DAITACHI will treat them with the highest sincerity and the most serious attitude. Among them, we combine good products, ownership skill and professional team knowledge. We help customers choose suitable products and solutions. We provide detailed installation tutorials and professional warranty services, so our customers always trust DAITACHI.

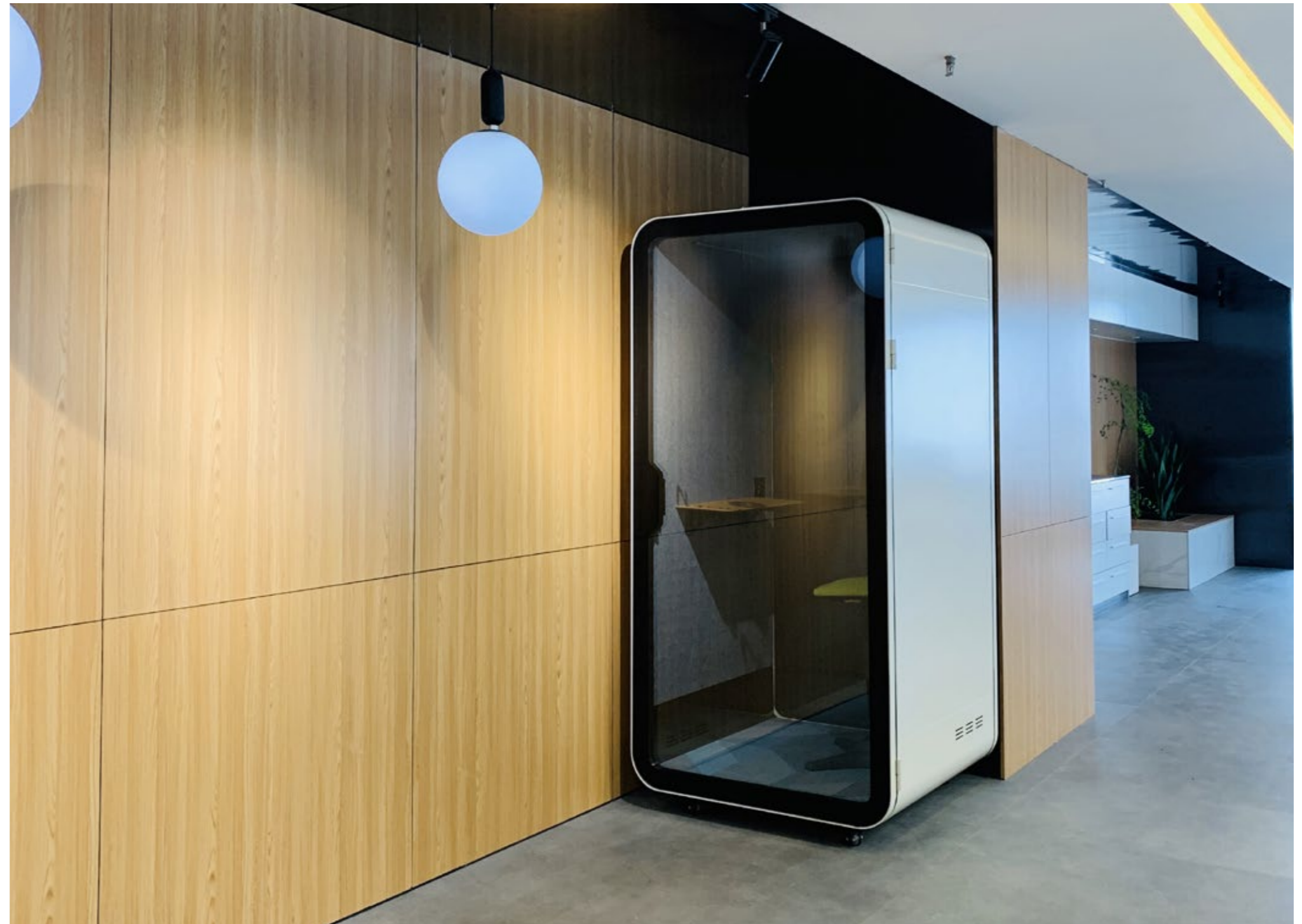

Fe BOX



According to research conducted by international authoritative organizations, more than 50% of office workers in the world believe that working in an open office space is a challenge, and more than half believe that continuous interference, footsteps, and noise will lead to a decrease in work efficiency and even unhappiness.

With the increasing number of distracting noises in the workplace in modern open office areas, it has become a difficult problem for people to solve.

The mission of "Fe Box" (Namely Phone Booth or Meeting Pod) is to change this situation,It is simple but significant. It is a perfect place for making important calls, private video conferences, brainstorming meetings and important one-on-one discussions, etc.

"Fe Box" (Namely Phone Booth or Meeting Pod) provide an echo-free and comfortable working environment to release the full potential of employees, improve their working habits and increase their work efficiency.



Phone



Office



Leisure



Read



1

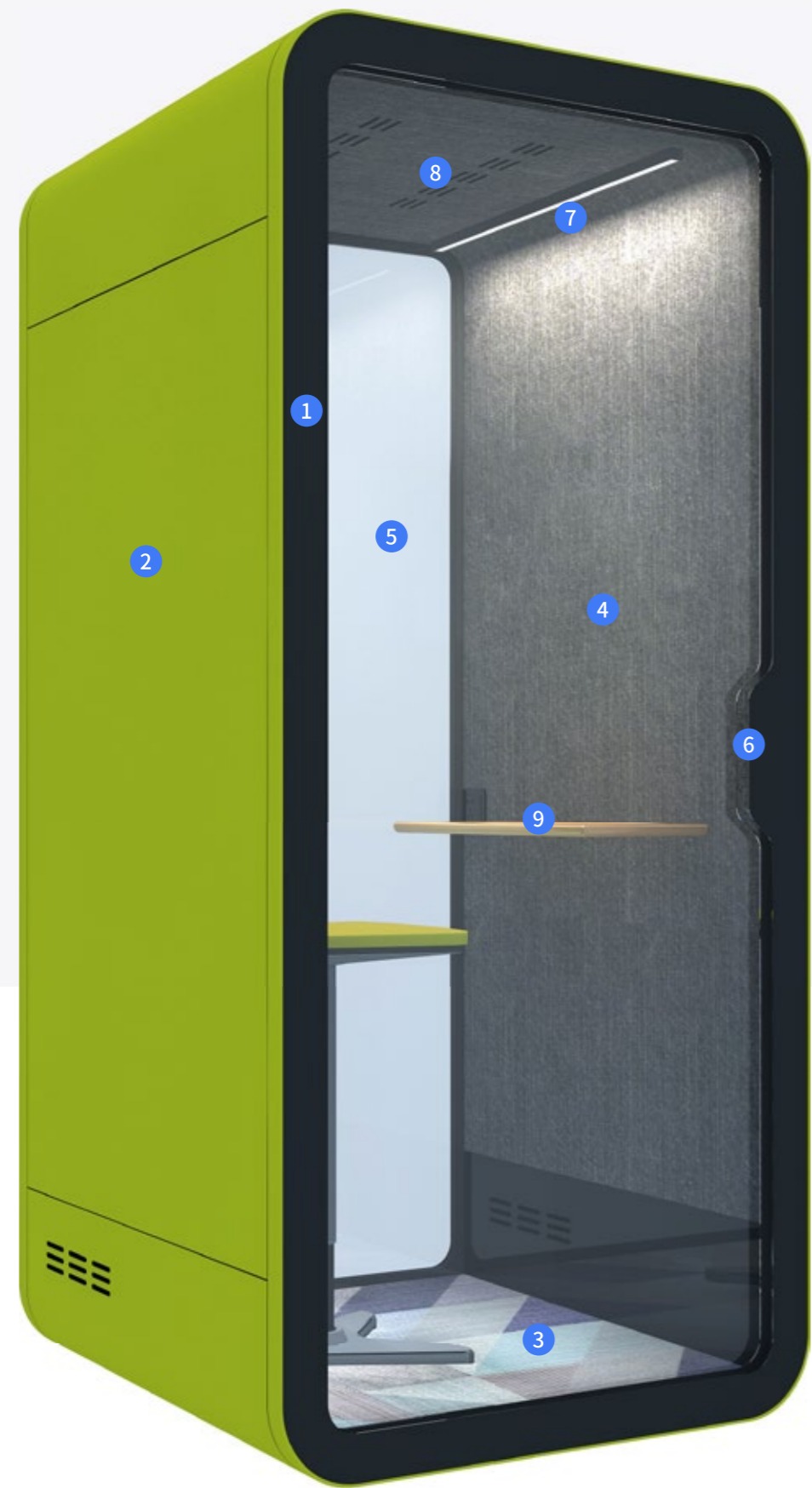

Fe⁺S

Product Parameters

- 1 **Internal Composition:**
Precision steel profile
- 2 **Exterior Finish:**
1.2mm spraying coat steel sheet
- 3 **High Quality Carpet:**
Milliken Carpet
- 4 **Interior Materials:**
Automotive grade sound-absorbing felt, sound-absorbing blanket
- 5 **Door Material:**
Crystal Double-glazed glass door
- 6 **Closing Method:**
Automatic closing (concealed door closer)
- 7 **Light Turn On:**
Photoelectric sensor on
- 8 **Ventilation System:**
Radar sensor on
- 9 **Furniture:**
Table
- 10 **Power System:**
100V-240V with usb socket
- 11 **Other:**
Movable casters wheel
- 12 **OEM:**
Yes

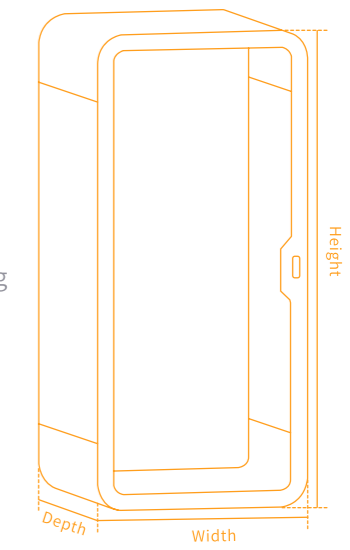

size

Exterior:
D1080mm*W1080mm*H2200mm

Interior:
D1000mm*W940mm*H2060mm

Color: Customazied

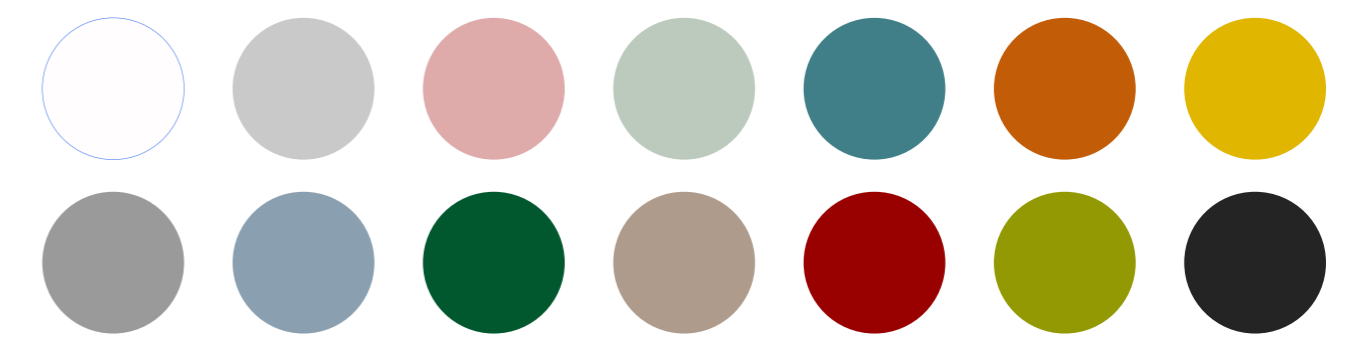

Customized Color

According to RAL International standard color card customization.



Product Details



Acoustic Insulation and Acoustic Interior

The wall panels are treated with special acoustic sound insulation components, the finishes are changeable, and the inner layer is a closed modular structure. Boxes and manual door with a transparent layer 10-12mm thickness double-glazed sound insulation, long life cycle, corrosion.

The interior box also uses high quality 9mm Burgeree sound-absorbing panel with flame retardant, combined with the cavity layer structure to form a broadband sound absorption, which eliminates strong reflections in the box, reduces internal depression, and increases space comfort. Also use environmental protection rubber strip, with multi-channel sealing technology, the sound insulation is incredibly increased to $R_w=33dB (\pm 2dB)$.

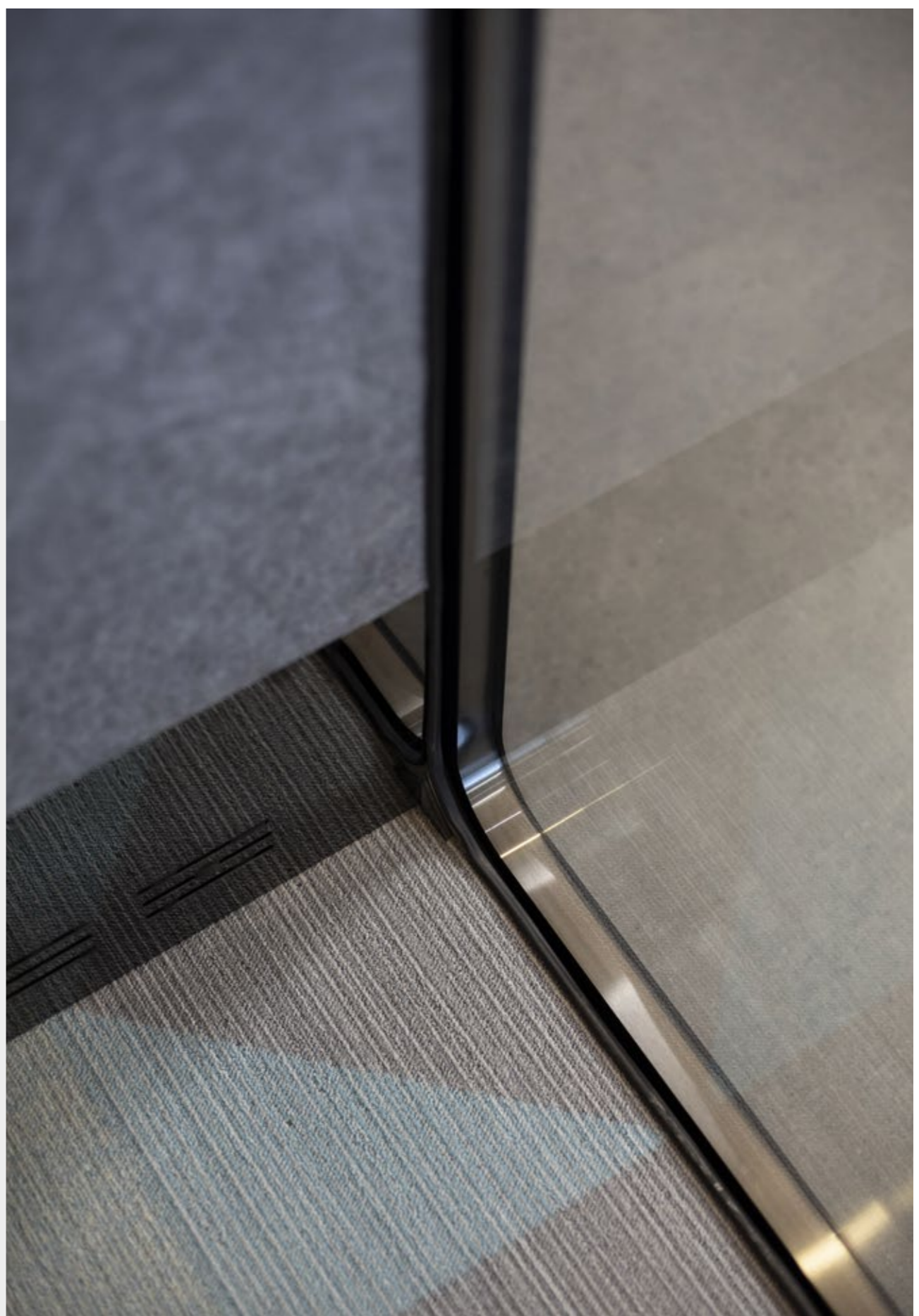

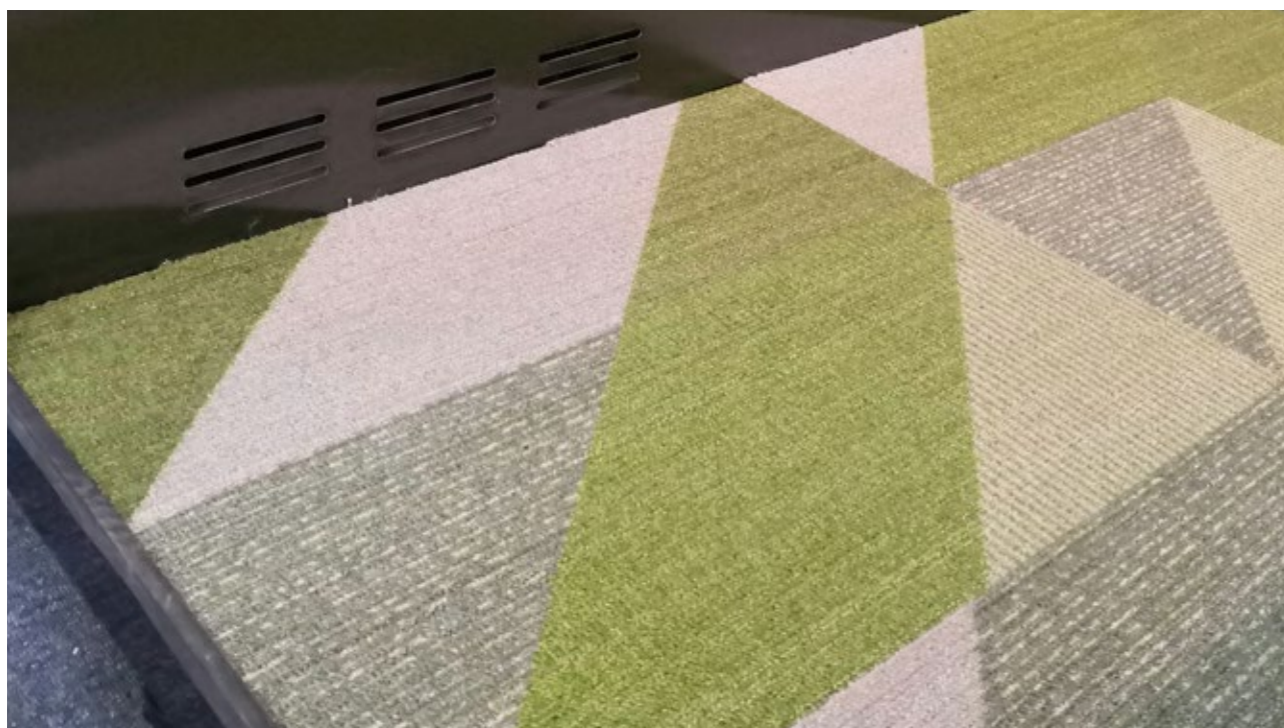

Milliken Carpet

Use the Milliken carpet, it is no taste and the surrounding will not roll up, the embedded installation method ensures the level of the box floor and is not easy to slide;
Environmental protection, abrasion resistance, anti-static, anti-fouling, anti-dust, anti-bacterial, long service life and ease of maintenance, reduce noise and create more warm and friendly rather than stereotyped atmosphere, making customers more comfortable and staff more concentrated spirit to work.
It can provide good thermal insulation performance, can improve the cold feeling under the feet of customers and staff, and enhance the comfort of the feet.

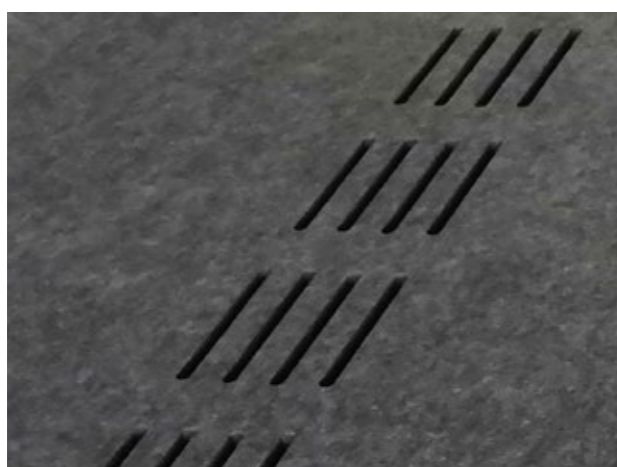

Ventilation

With Radar automatic motion sensor;
Low noise exhaust, the wind comes in and the sound cannot come out;
700m³/hour and Automatic air supply;
The fan speed is 2000rpm to ensure the air comfort and air quality inside the box, the Air in the box can be circulated in three minutes, it won't be stuffy in the box;

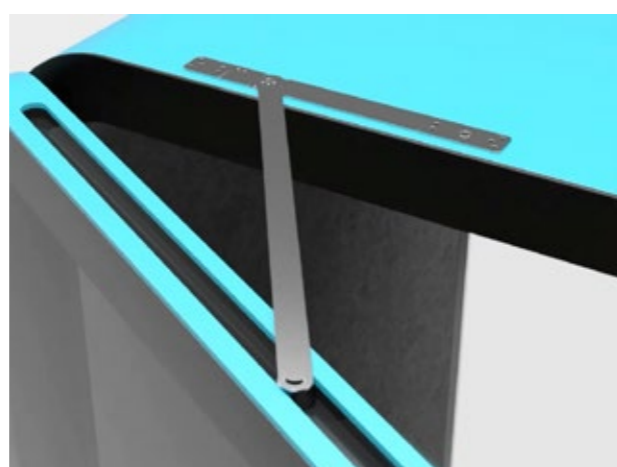

German GEZE Concealed Door Closer

Concealed door lock hardware, it is good-looking and convenient;
Use the German GEZE Concealed Door Closer, it is completely hidden in the door leaf. The slide rail is only visible when the door is open. It can be used on single-leaf doors that open to the right or left. The door closing force complies with DIN EN 1154 standard. After the door closer is installed, the door closing speed, hydraulic limit and hydraulic door opening buffer can be easily adjusted.

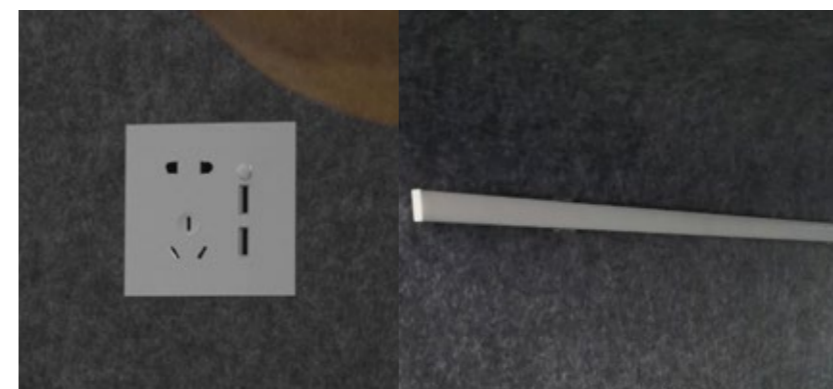

Lighting & Power

With Radar automatic motion sensor;
The box is outfit with 3000K induction lighting system, with 100-230V power supply and with 5V USB socket.



Table

The table is folded and unpainted, can increase space and environmental protection.



Removable Hinge

The hinge is removable, the door and the frame can be easily separated and disassembled, and the installation is also convenient, reducing the time spent on Assembly.



Smart Radar Sensor

The interior of the box is equipped with Radar automatic motion sensor to determine there are people in the box or not, so as to control the turn on or turn off of the ventilation and light system.



Liftable Movable Casters Wheel & Support

The bottom of Fe box is equipped with universal wheels and adjustable screw support, which makes the cabin move fast and convenient.

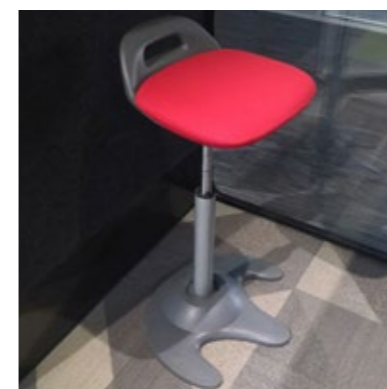

Liftable High Chair (Optional Extra)

liftable and can shake left and right, humanized design and will not get lumbar muscle strain.



Hook

Hook is made of aluminum material, can hang Handbags, clothes, small things, easy to use and convenient.





Fe⁺M

Product Parameters

- 1 Internal Composition:**
Precision steel profile
- 2 Exterior Finish:**
1.2mm spraying coat steel sheet
- 3 High Quality Carpet:**
Milliken Carpet
- 4 Interior Materials:**
Automotive grade sound-absorbing felt, sound-absorbing blanket
- 5 Door Material:**
Crystal Double-glazed glass door
- 6 Closing Method:**
Automatic closing (concealed door closer)
- 7 Light Turn On:**
Photoelectric sensor on
- 8 Ventilation System:**
Radar sensor on
- 9 Power System:**
100V-240V
- 10 Other:**
Movable casters wheel
- 11 OEM:**
Yes

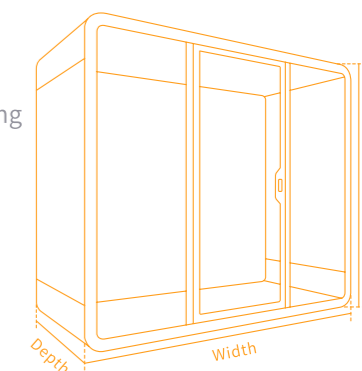

size
Exterior:
D1280mm*W2200mm*H2200mm
Interior:
D1200mm*W2060mm*H2060mm

Color: Customazied

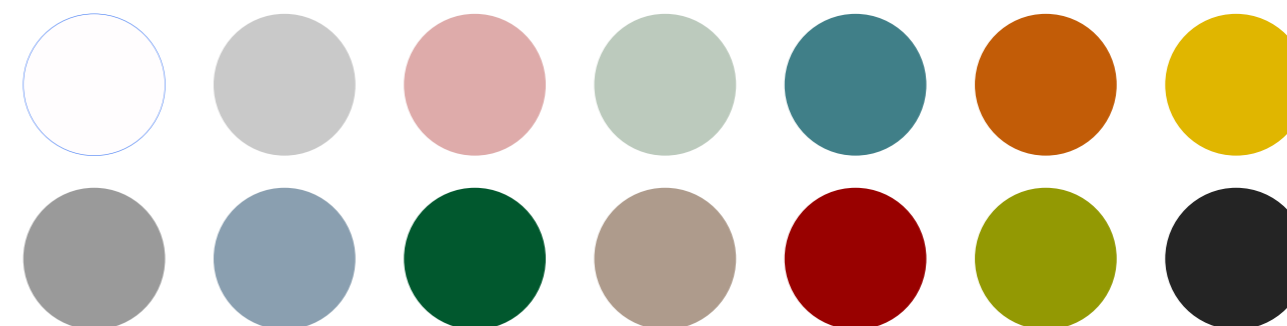

Customized Color

According to **RAL** International standard color card customization.



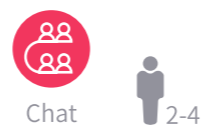

Fe⁺C

Product Parameters

- 1 **Internal Composition:**
Precision steel profile
- 2 **Exterior Finish:**
1.2mm spraying coat steel sheet
- 3 **High Quality Carpet:**
Milliken Carpet
- 4 **Interior Materials:**
Automotive grade sound-absorbing felt, sound-absorbing blanket
- 5 **Door Material:**
Crystal Double-glazed glass door
- 6 **Closing Method:**
Automatic closing (concealed door closer)
- 7 **Light Turn On:**
Photoelectric sensor on
- 8 **Ventilation System:**
Radar sensor on
- 9 **Power System:**
100V-240V with usb socket
- 10 **Other:**
Movable casters wheel
- 11 **OEM:**
Yes

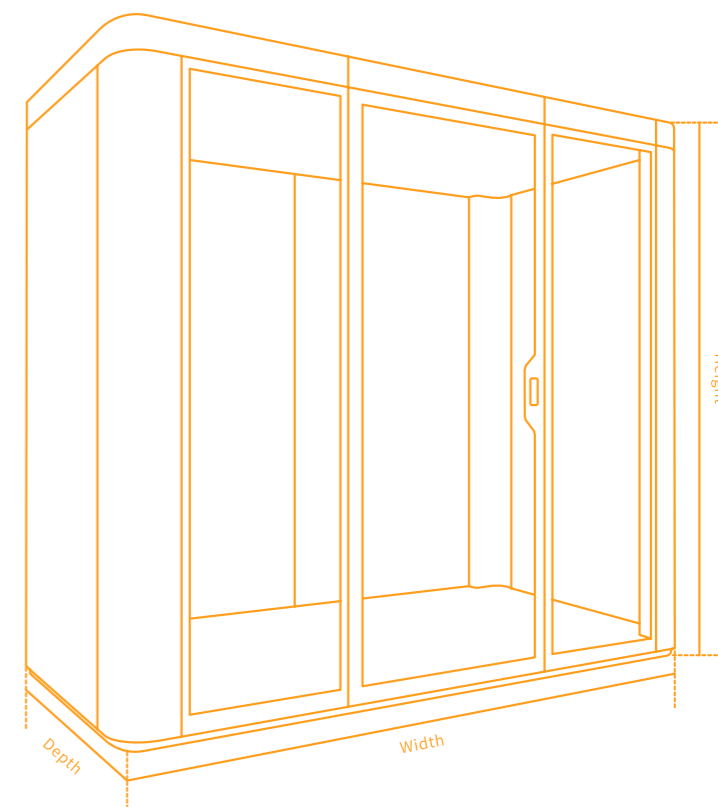

size
 Exterior: D1200mm*W2200mm*H2200mm
 Interior: D1120mm*W2060mm*H2060mm



Phone



Read



Leisure



Office

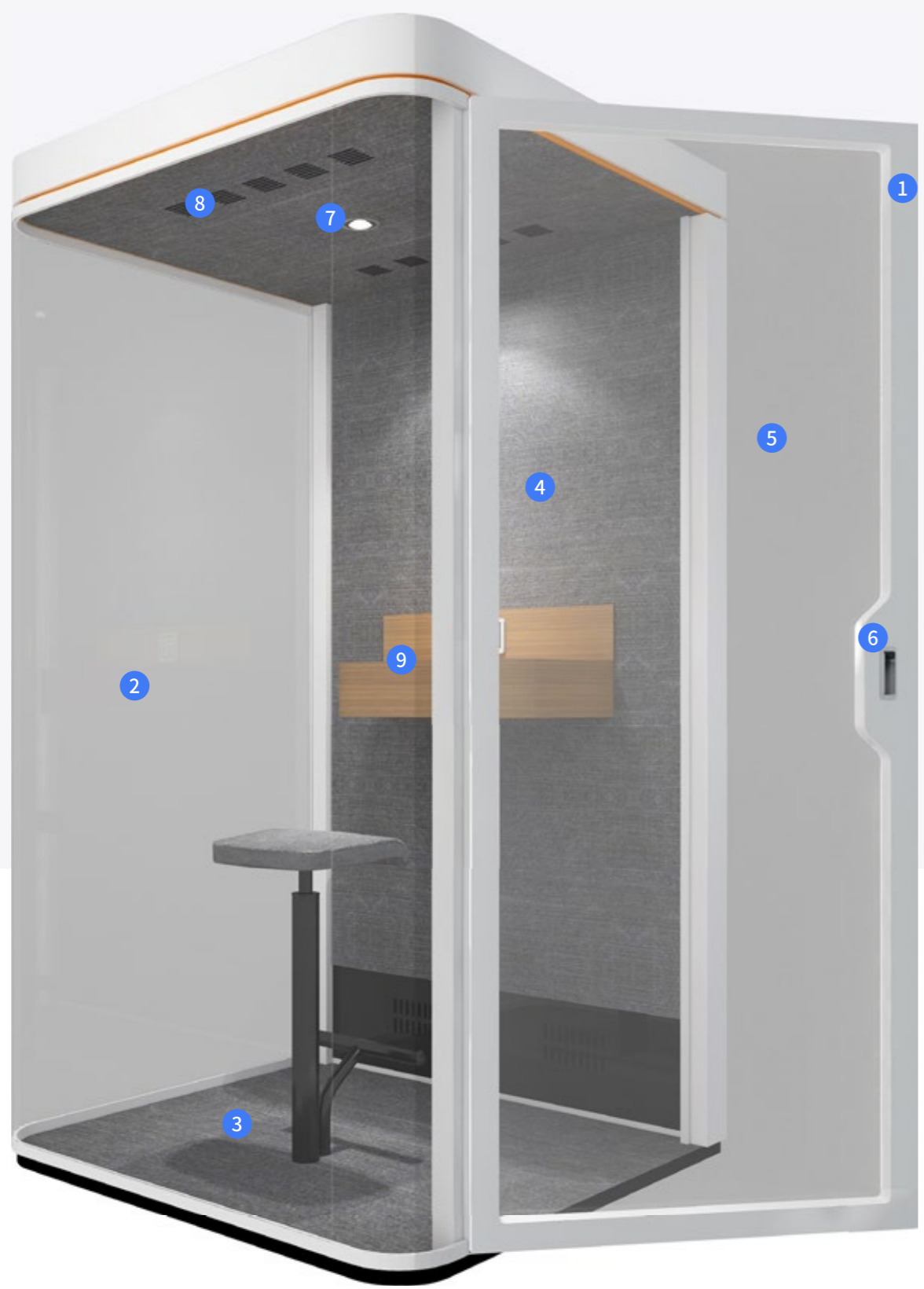

Fe⁺R

Product Parameters

- 1 Internal Composition:**
Precision steel profile
- 2 Exterior Finish:**
1.2mm spraying coat steel sheet
- 3 High Quality Carpet:**
Milliken Carpet
- 4 Interior Materials:**
Automotive grade sound-absorbing felt, sound-absorbing blanket
- 5 Door Material:**
Crystal Double-glazed glass door
- 6 Closing Method:**
Automatic closing (concealed door closer)
- 7 Light Turn On:**
Photoelectric sensor on
- 8 Ventilation System:**
Radar sensor on
- 9 Furniture:**
Table
- 10 Power System:**
100V-240V with usb socket
- 11 Other:**
Movable casters wheel
- 12 OEM:**
Yes

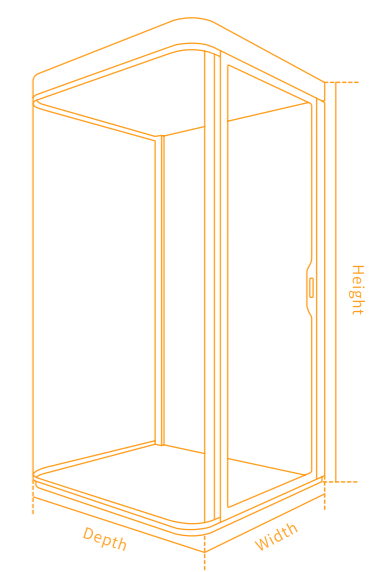

size

Exterior:
D1000mm*W1000mm*H2200mm

Interior:
D920mm*W860mm*H2060mm

Color: Customazied

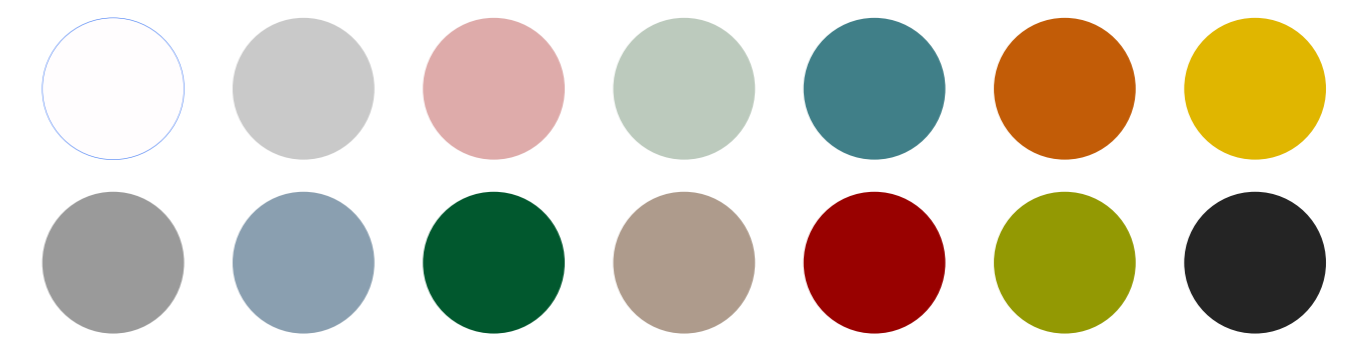



Phone



Read



Leisure



Office



1+

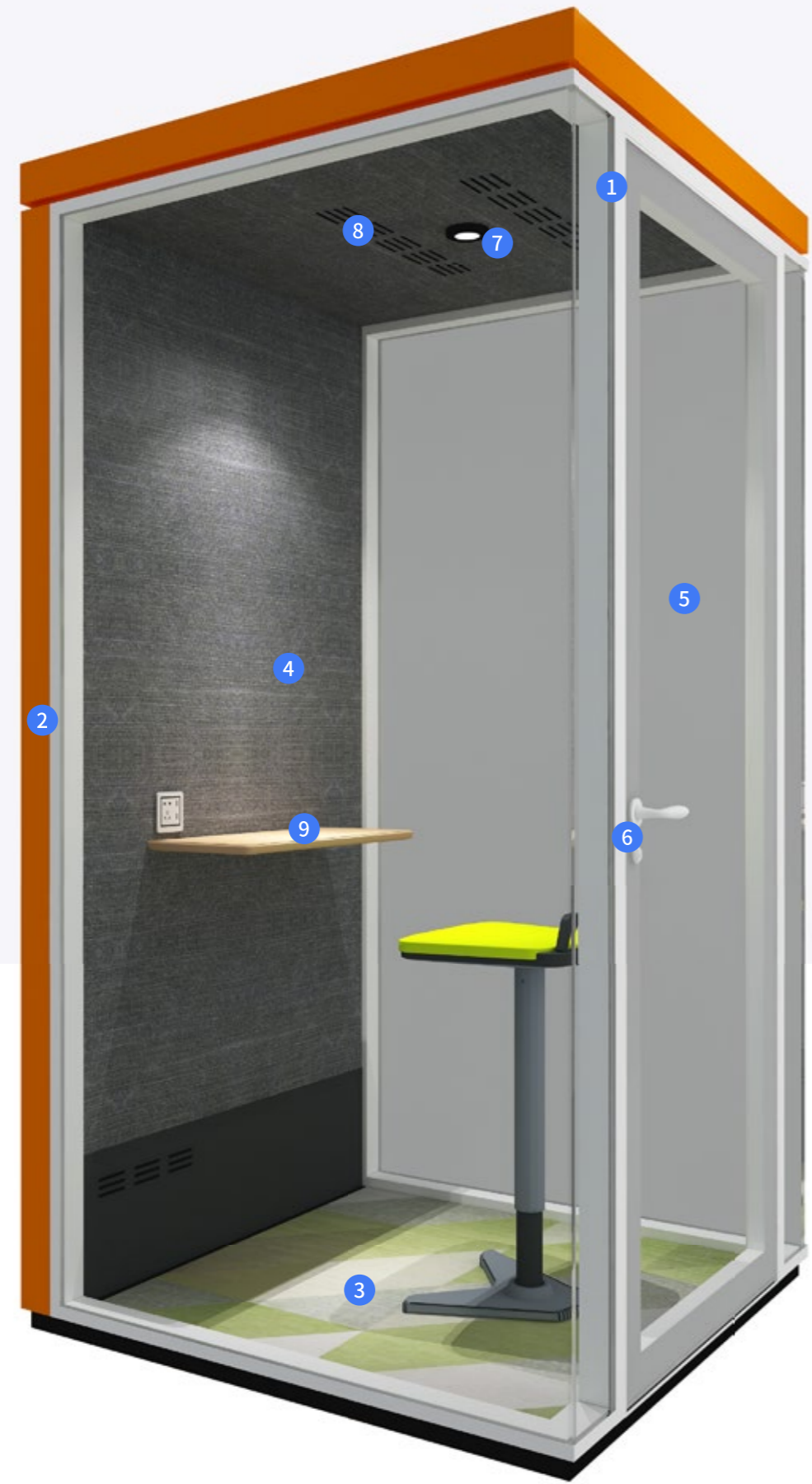

Fe⁺G

Product Parameters

- 1 Internal Composition:**
Precision steel profile
- 2 Exterior Finish:**
1.2mm spraying coat steel sheet
- 3 High Quality Carpet:**
Milliken Carpet
- 4 Interior Materials:**
Automotive grade sound-absorbing felt, sound-absorbing blanket
- 5 Door Material:**
Crystal Double-glazed glass door
- 6 Closing Method:**
Automatic closing (concealed door closer)
- 7 Light Turn On:**
Photoelectric sensor on
- 8 Ventilation System:**
Radar sensor on
- 9 Furniture:**
Table
- 10 Power System:**
100V-240V with usb socket
- 11 Other:**
Movable casters wheel
- 12 OEM:**
Yes

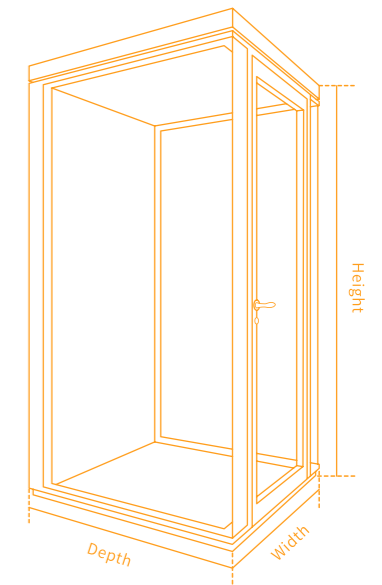

size
 Exterior:
 D1200mm*W1200mm*H2200mm
 Interior:
 D1120mm*W1060mm*H2060mm

Color: Customazied

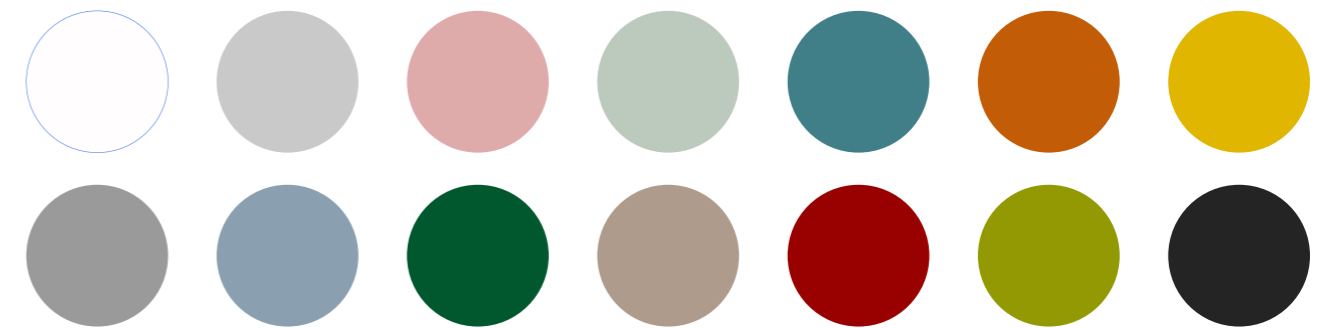

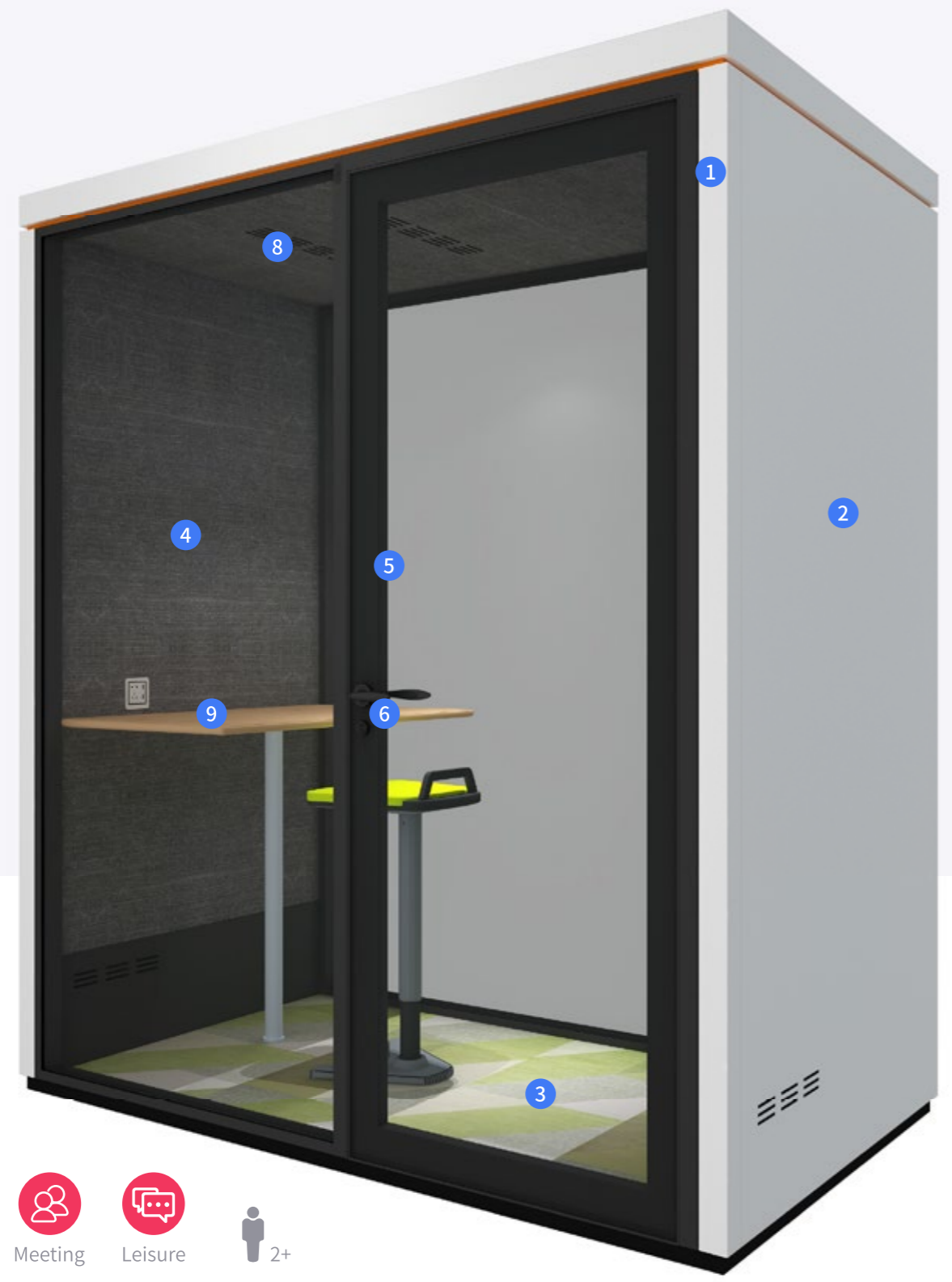

-  Meeting
-  Leisure
-  2+

Fe+W

Product Parameters

- 1 Internal Composition:**
Precision steel profile
- 2 Exterior Finish:**
1.2mm spraying coat steel sheet
- 3 High Quality Carpet:**
Milliken Carpet
- 4 Interior Materials:**
Automotive grade sound-absorbing felt, sound-absorbing blanket
- 5 Door Material:**
Crystal Double-glazed glass door
- 6 Closing Method:**
Automatic closing (concealed door closer)
- 7 Light Turn On:**
Photoelectric sensor on
- 8 Ventilation System:**
Radar sensor on
- 9 Power System:**
100V-240V with usb socket
- 10 Other:**
Movable casters wheel
- 11 OEM:**
Yes

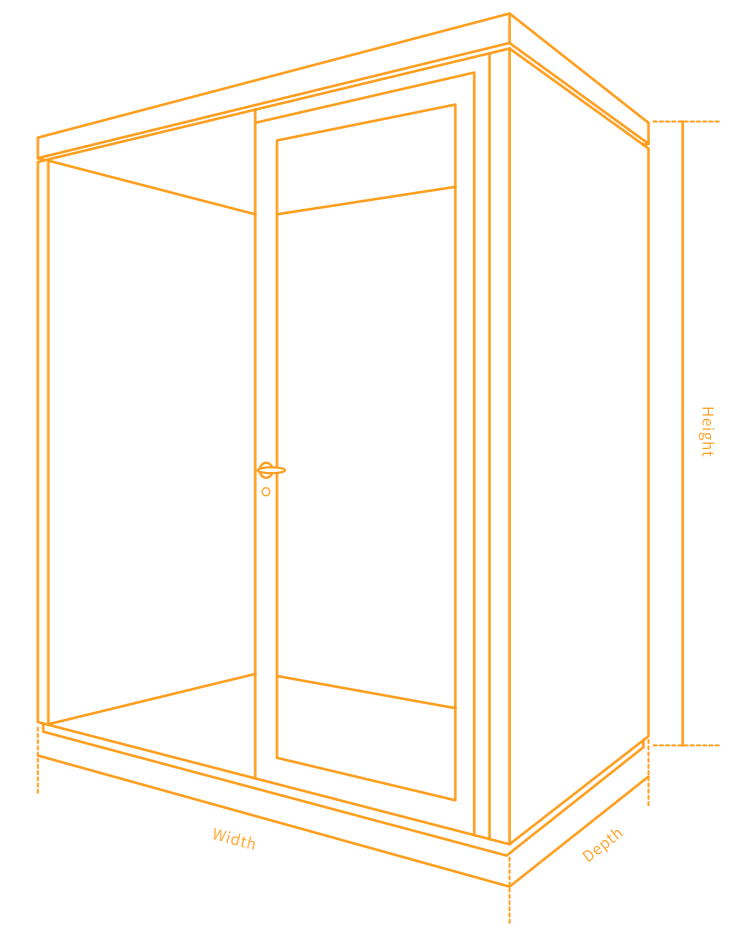

size
 Exterior: D1200mm*W2000mm*H2200mm
 Interior: D1120mm*W1860mm*H2060mm

Application

Office (for making important calls, private video conferences, brainstorming meetings and important one-on-one discussions, etc);
Temporary Office; Live; Recording Studio; Education Training;
Study Room; Workshop; Read; Leisure;
Need Private space place. etc

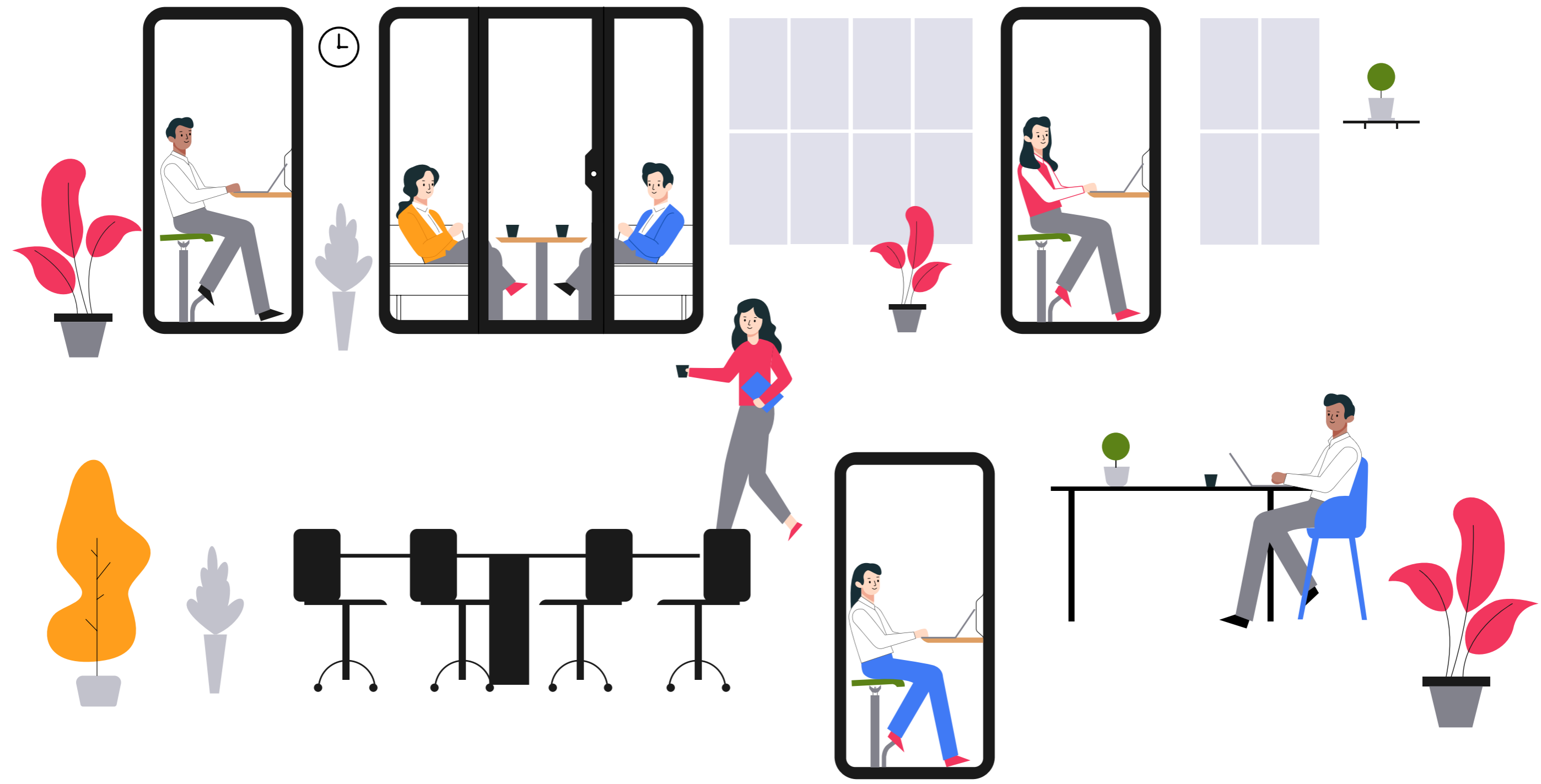

Acoustic Test Result

NIC=33

Fe Box Production Process

Test Result

Table 1 The sound power level

Frequency/Hz	Sound power level/dB		
	With telephone booth	Without telephone booth	Difference
100	61.8	81.5	19.7
125	68.3	82.1	13.8
160	72.7	84.6	11.9
200	63.1	86.7	23.5
250	54.7	84.1	29.4
315	55.8	83.2	27.4
400	59.1	81.8	22.7
500	56.9	81.4	24.5
630	56.2	80.7	24.5
800	50.2	80.5	30.3
1000	49.4	80.7	31.3
1250	49.2	81.2	32.0
1600	48.7	83.8	35.1
2000	48.0	87.8	39.8
2500	48.7	88.4	39.7
3150	47.8	89.1	41.3
4000	43.7	88.9	45.2
5000	43.3	92.7	49.5
6300	42.0	93.3	51.3
8000	36.9	89.2	52.3
10000	31.9	83.7	51.8

Note: According to the standard the measurement frequency range is 100Hz-10000Hz, and the difference is the sound power level of the sound source without the telephone booth minus the sound power level of the sound source with the telephone booth. The test results reported in this report are based on laboratory measurements.

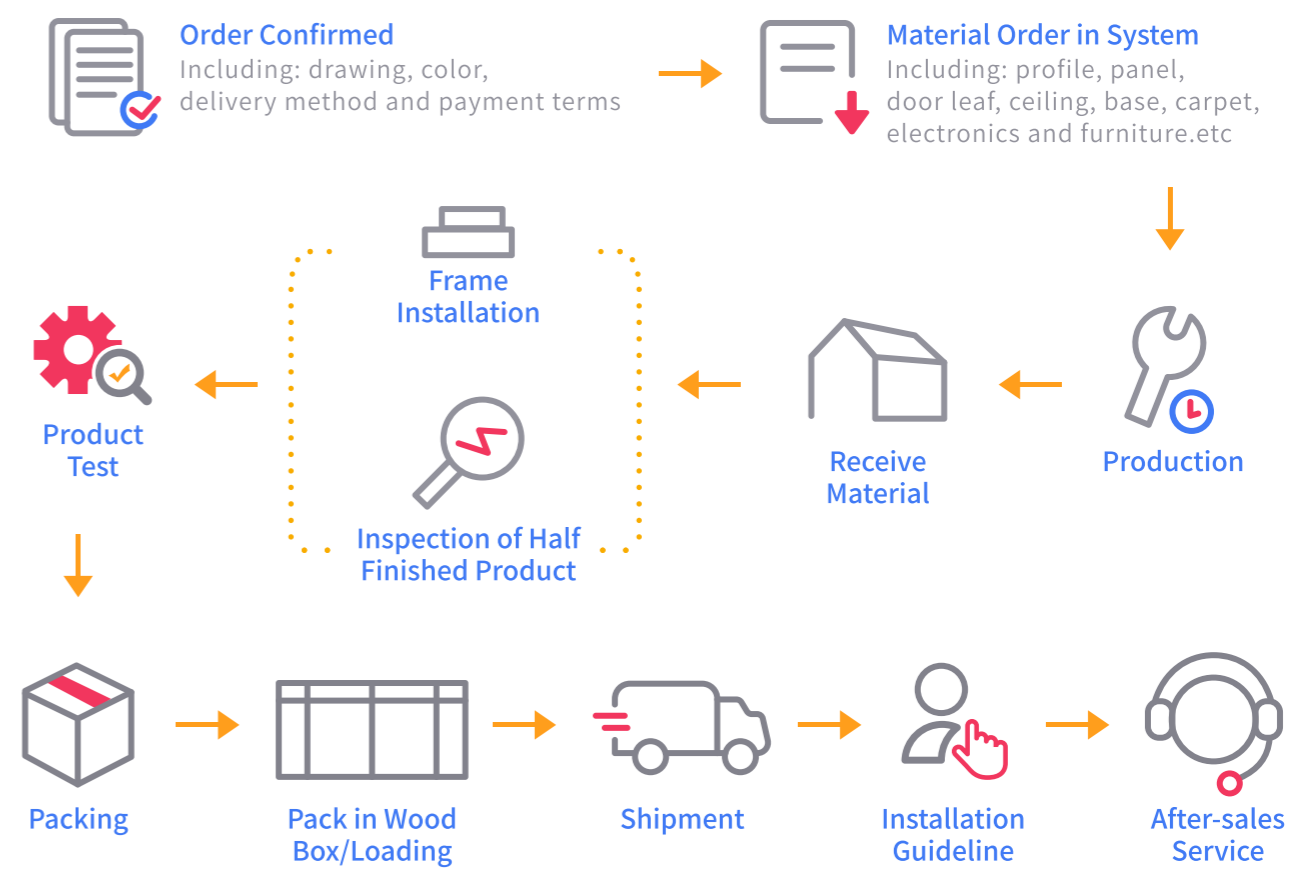
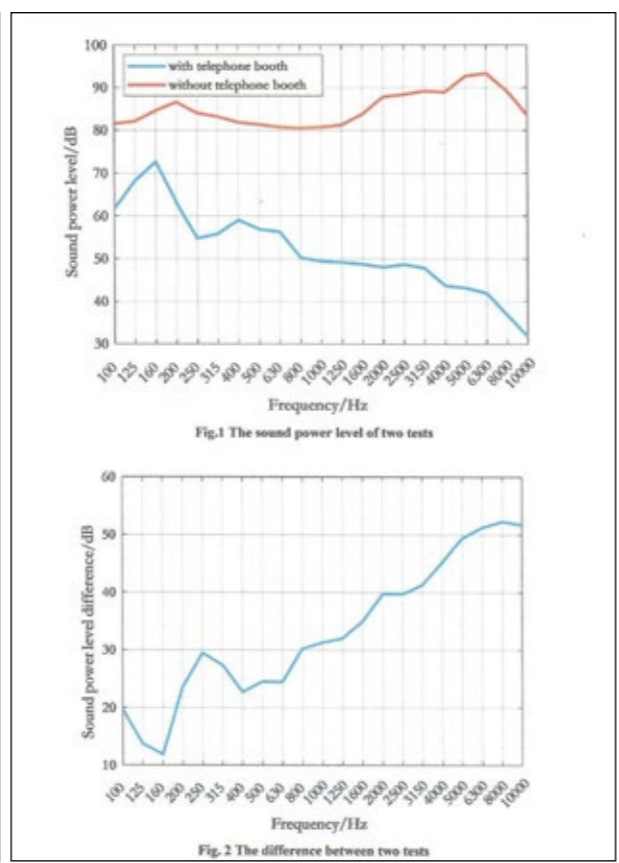

Welcome to Inquiry and Visit Us!

Office Address: 307, Building 5, Xinsheng Technopark, No.2, Xintang Street,
Da Guan Middle Road, Tianhe District, Guangzhou, China

Factory Address: No. 50, Xianxi Reservoir West Road, Shishan Town, Nanhai District,
Foshan City, Guangdong Province, China.

Building 1, Mubei Industrial Park, No.5 Mubei East Road,
Tianhe District, Guangzhou, China

Website: www.daitachipartitionwall.com

Tel: +86 020-2383-8479

Fax: +86 020-3473-1789

Contact Person: Paul Huang (Manager)

E-mail: paulhuang@daitachipartitionwall.com

Mobile: +86 186-8889-7933

